

SIRUBA®

銀爺牌工業用縫紉機

INDUSTRIAL SEWING MACHINE

L818F-RM1

零件圖 PARTS LIST



CE



高林股份有限公司
KAULIN MFG. CO., LTD.

MODEL 機型	SUB-CLASS 規格	GAUGE WIDTH 切邊距離	NEEDLE PLATE 針板	FEED DOG 送具	PRESSER FOOT 押具	HOOK ASM 梭頭	BOBBIN CASE ASM 梭殼	BOBBIN 梭子	THROAT PLATE CHIP GUARD 下導布架	NEEDLE 針號	THREAD GUIDE 導線片	THROAT PLATE COVER 布板蓋
L818F-RM1-32	32	1/8" (3.2mm)	E705Q	D705	P705	G111	G201	G301	LR104DS	DB*1#14	LR141S	LR106
L818F-RM1-40	40	5/32" (4.0mm)	E705R (E705Q)	D705	P705	G111	G201	G301	LR104DS	DB*1#14	LR141S	LR106
L818F-RM1-48	48	3/16" (4.8mm)	E705 (E705Q)	D705	P705	G111	G201	G301	LR104DS	DB*1#14	LR141S	LR106
L818F-RM1-64	64	1/4" (6.4mm)	E705S (E705Q)	D702 (D705)	P701 (P705)	G111	G201	G301	LR104D (LR104DS)	DB*1#14	LR141 (LR141S)	LR106S (LR106)
L818F-RM1-95	95	3/8" (9.5mm)	E705T (E705Q)	D702 (D705)	P701 (P705)	G111	G201	G301	LR104D (LR104DS)	DB*1#14	LR141 (LR141S)	LR106T (LR106)

規格件表 CONVERSION CHART

PARTS LIST FOR LA GROUP

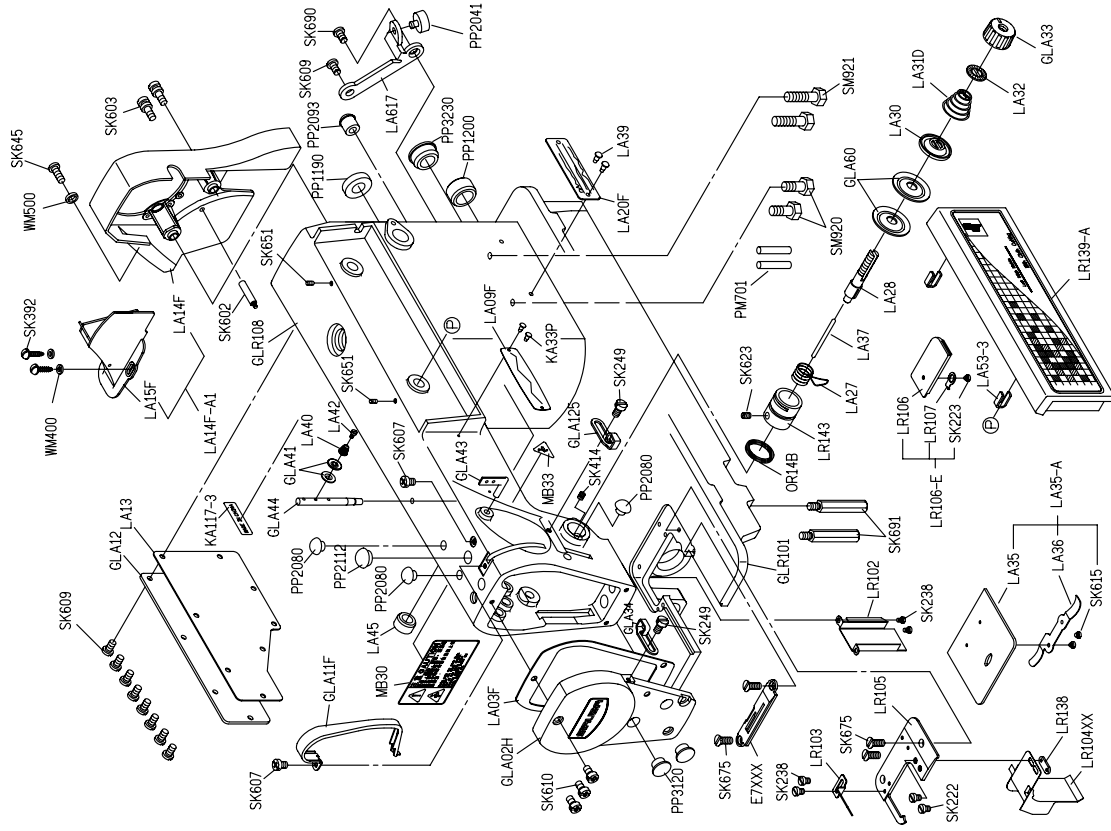

PARTS LIST FOR LB GROUP

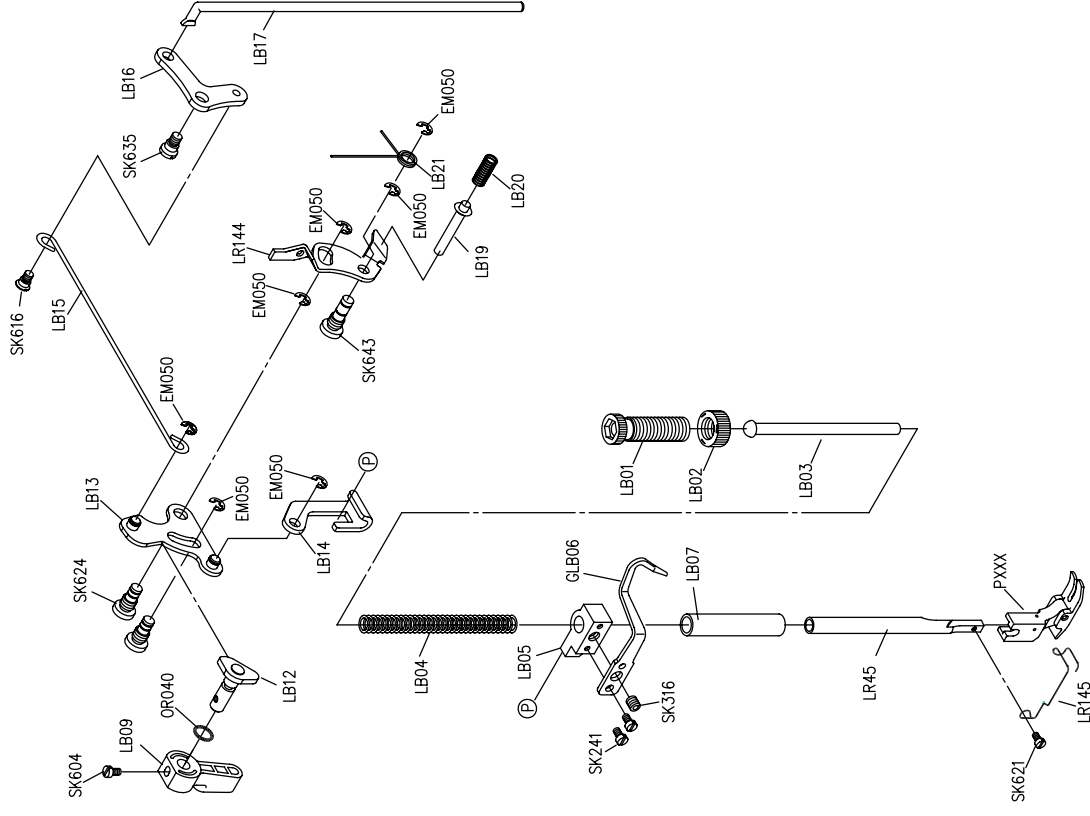

PARTS LIST FOR LE GROUP

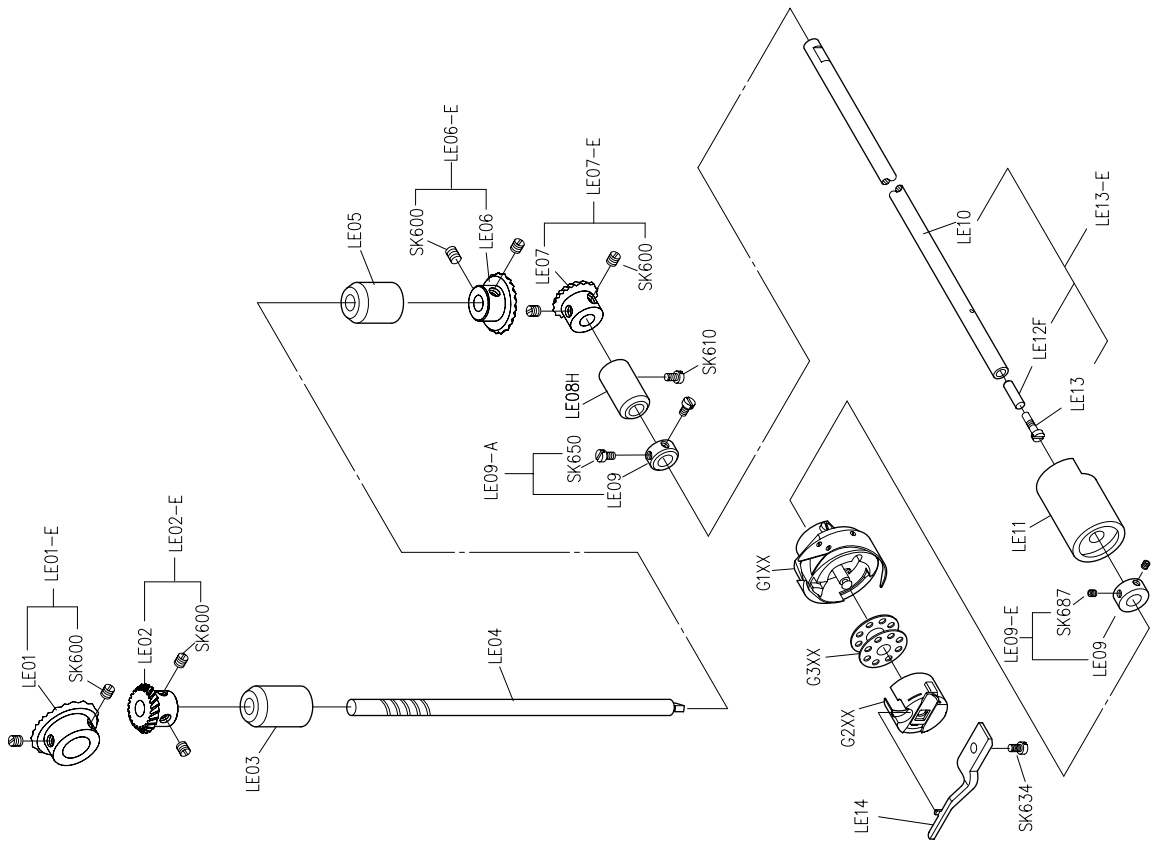

PARTS LIST FOR LG GROUP

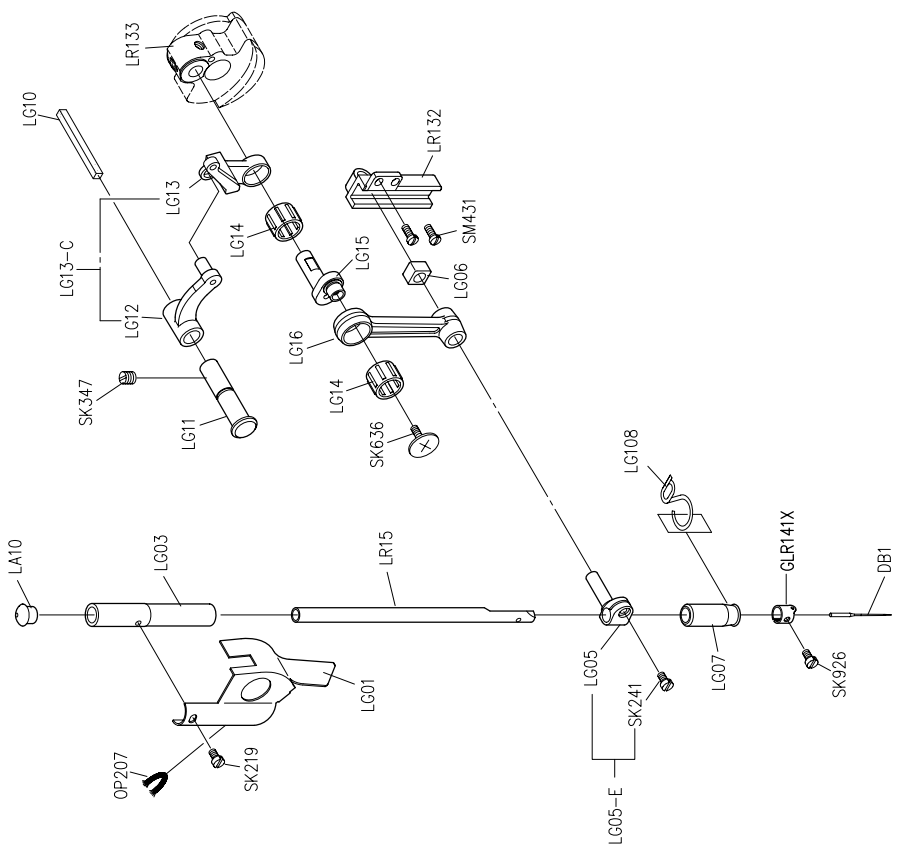

PARTS LIST FOR LM GROUP

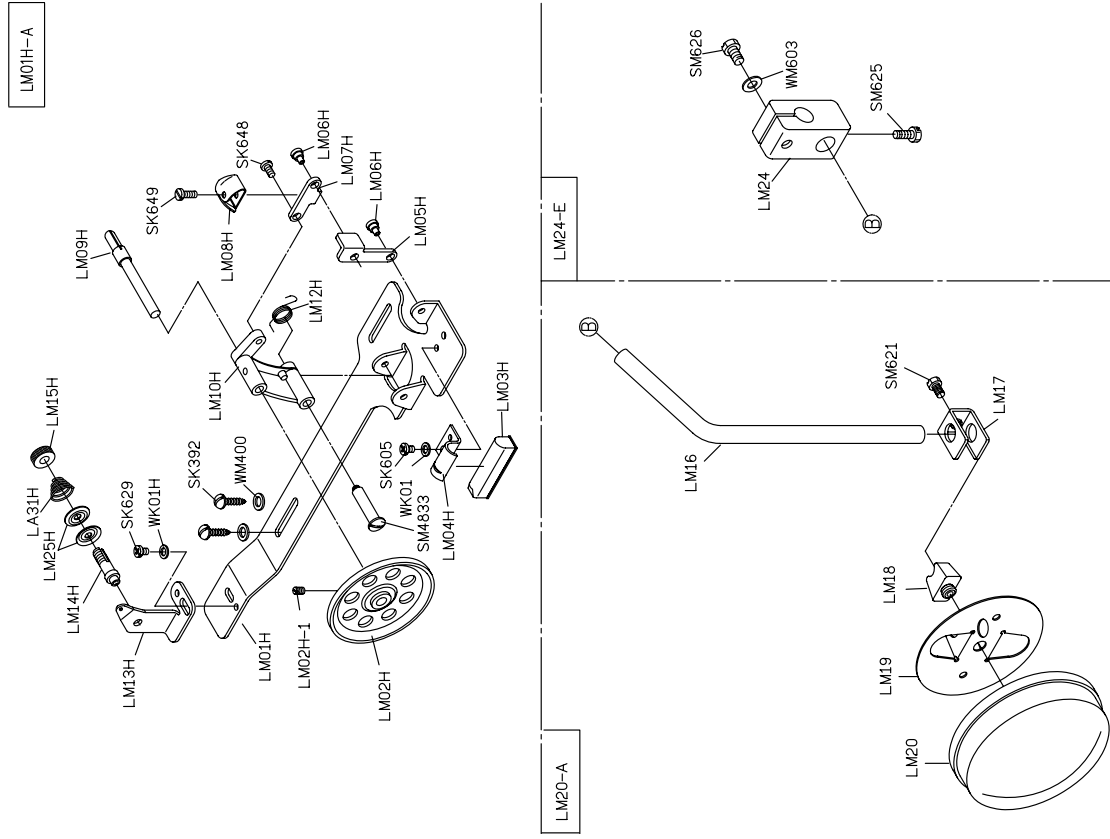

PARTS LIST FOR LR GROUP

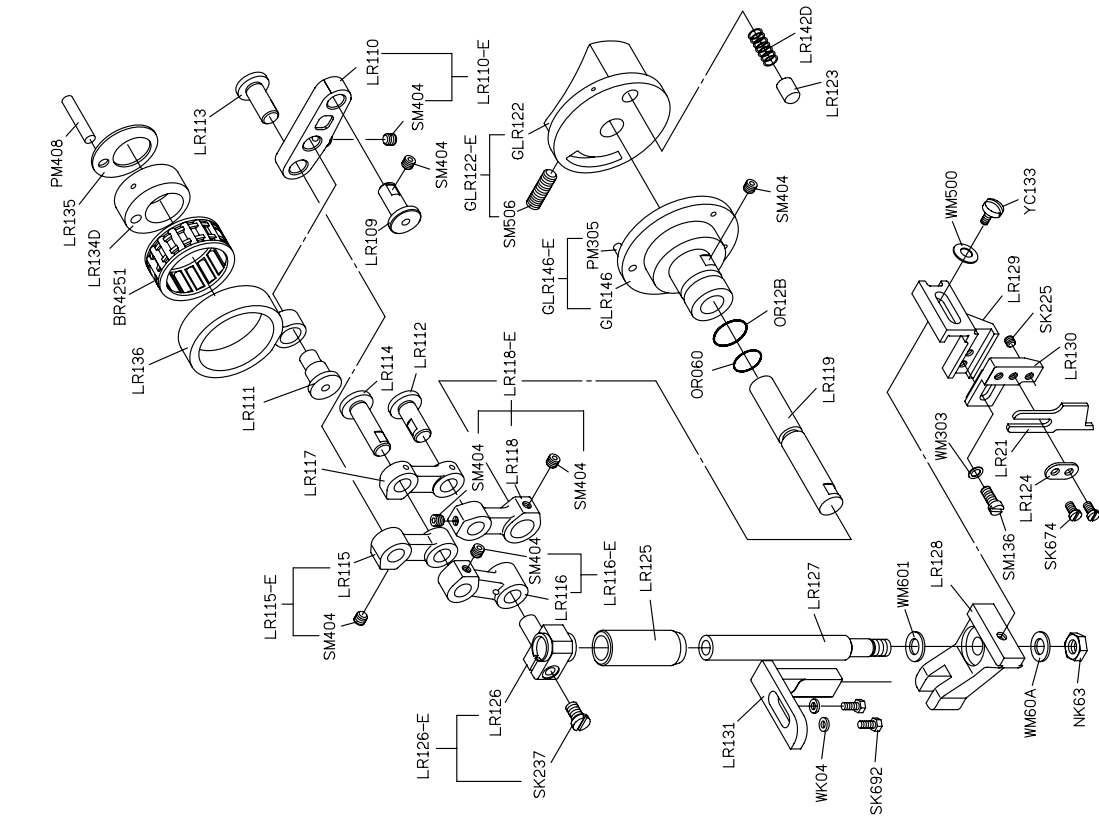

LY01



LY02



YM04*2

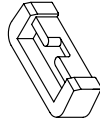

LY05*2

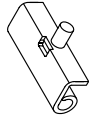

YM102*2



LY08F

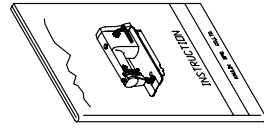

LY19

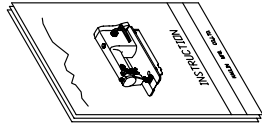

LY24

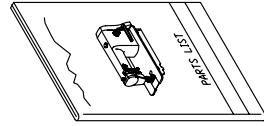

LY21-A

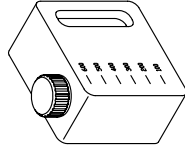

YM103*2



G3XX*2



針*2



GMT01

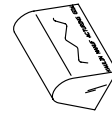

MY11



KZ03*1



LY33

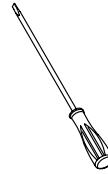

LY34

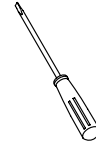

LY35

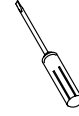

LY23H

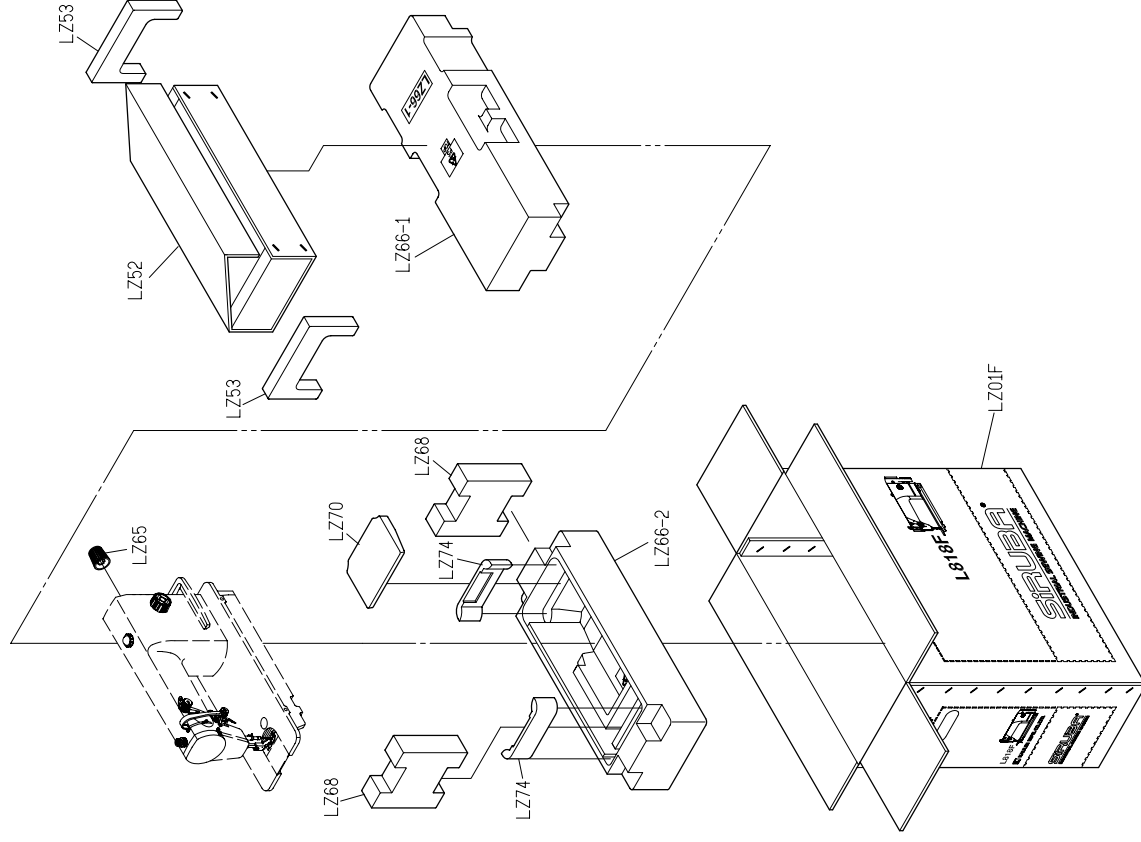

PARTS LIST FOR THREAD STAND GROUP

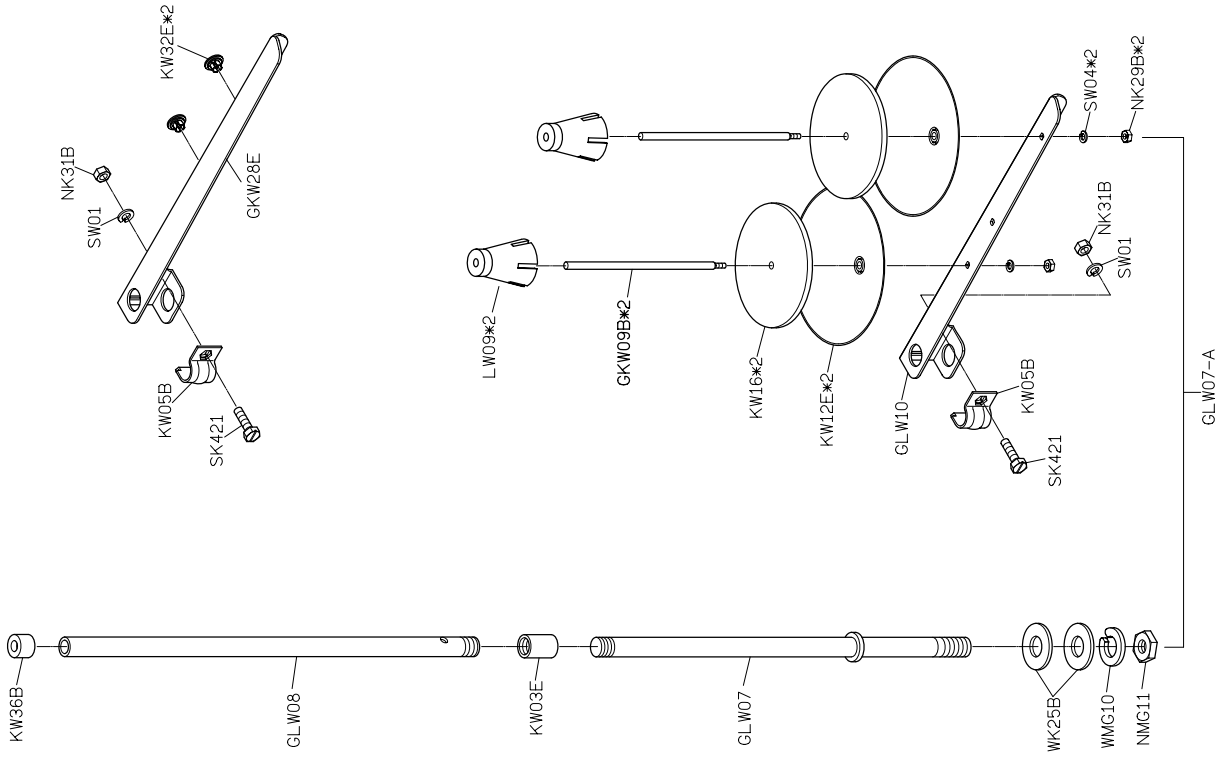



L818F-RM1

高林股份有限公司 KAULIN MFG. CO., LTD.